

# Instruction Manual

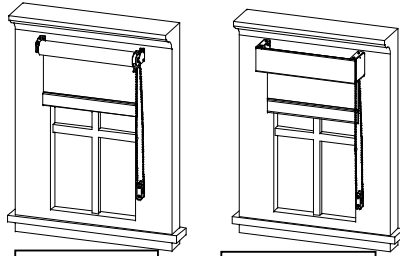

Manual roller shade

Manual roller shade with Fascia

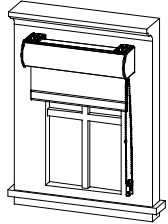



Manual roller shade with Cassette

### Recommended Tools

- Power drill
- Tape Measure
- Screwdriver
- Level ruler
- Pencil



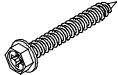
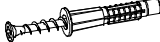



### Fasteners needed for different mounting surfaces:





Mounting Surface	Fastener
Wood	1 1/4" Screw(Provided) 
Drywall/Plaster	Wall Anchors, Expansion Bolts(Not Provided) 
Metal	Sheet Metal Screws(Not Provided) 

### Hardware included

#### 1、 Manual roller shade



Hardware	Picture	Usage
1 1/4" hexagon screw		installing bracket
Bracket		Installing shade(clutch side)
Bracket		Installing shade(end plug side)
2" flat head screw		Installing safety device

#### 2、 Manual roller shade with Fascia



Hardware	Picture	Usage
1 1/2" hexagon screw		installing bracket
Bracket		Installing shade(clutch side)
Bracket		Installing shade(end plug side)
Bracket end cap		Outside mount only
2" flat head screw		Installing safety device

#### 3、 Manual roller shade with Cassette

##### (1) Small Cassette

Hardware	Picture	Usage
1 1/4" hexagon screw		installing mounting bracket
1 1/4" L shape mounting bracket		mounting shade
2" flat head screw		Installing safety device

##### (2) Large Cassette

Hardware	Picture	Usage
1 1/4" hexagon screw		installing mounting bracket
79x45mm mounting bracket		mounting shade
2" flat head screw		Installing safety device

### Manual roller shade installation or removal

- **Installation:**  
The brackets for both ends of the shade should be on

the same level. Make sure the bracket for clutch and end plug is on the correct side respectively.

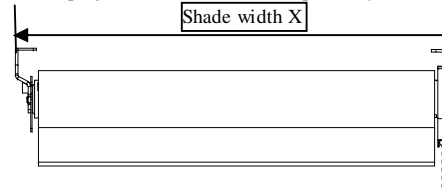

### For inside mount

- The distance from the front mounting hole of brackets to the front edge of window frame should be more than 3/4". Ensure both of the brackets are at the same horizontal line. Each bracket needs two 1 1/4" hexagon screws for installing.

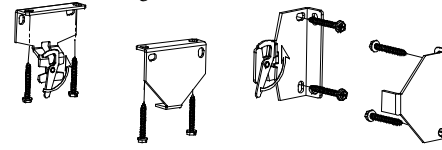

option 1: screws upward    option 2: screws sideward

### For outside mount

- The top of each bracket is parallel with the edge of window frame. The distance from the mounting holes of the brackets to the front edge of window frame should be at the same horizontal line. Each bracket needs two 1 1/4" hexagon screws for installing.

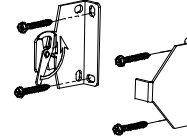

### Install shade to the brackets

- Install shade (clutch side) to the clutch bracket, and then the end plug side to the "V" of end plug bracket, rotate the removable pin of the end plug bracket till the shade is firmly installed.

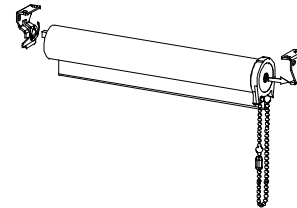

- **Removal:**  
Rotate the removable pin of the end plug

bracket, detach the shade (end plug side) from the "V" of the bracket and then remove the clutch side from the bracket.

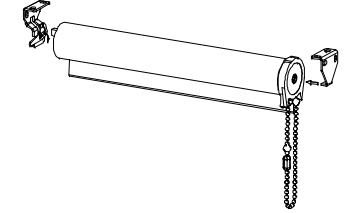

### Manual roller shade with Fascia installation

#### or removal

- **Installation:**  
The brackets for both ends of the shade should be on the same level. Make sure the bracket for clutch and end plug is on the correct side respectively.

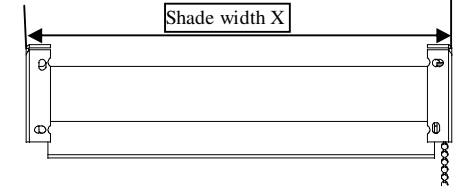

### For inside mount

- The distance from the front mounting hole of brackets to the front edge of window frame should be more than 3/4". Ensure both of the brackets are at the same horizontal line. Each bracket needs two 1 1/2" hexagon screws for installing.

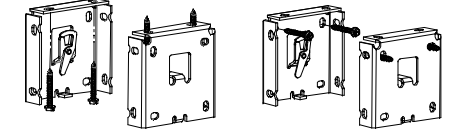

option 1: screws upward    option 2: screws sideward

### For outside mount

- The top of each bracket is parallel with the edge of window frame. The distance from the mounting holes of brackets to the front edge of window frame should be more than 3/4". Both of the brackets should be at the same horizontal line. Each bracket needs two 1 1/2" hexagon screws for installing.

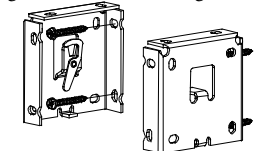

### Install shade to the brackets

- Install shade (clutch side) to the clutch bracket, and then the end plug side to the "V" of end plug bracket, rotate the removable pin of the end plug bracket till the shade is firmly installed.

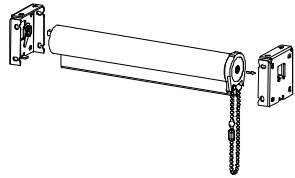

- Attach Fascia and end cap after shade is installed. (note: end cap is for outside mount only)

Hook the top lip of the Fascia to the top of bracket, swing the bottom of the Fascia towards the bracket and gently press at the bottom of the Fascia until the lip on the Fascia engages and snaps locked to the bracket.

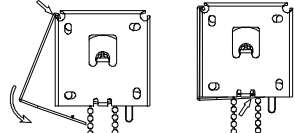

After Fascia is installed, affix end caps to the brackets.

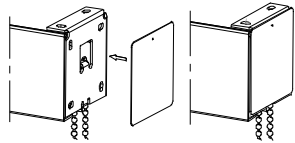

### Removal:

1. Detach the bottom lip of the Fascia from the bracket, and then lift the Fascia upward slightly. The top lip of Fascia will be away from the bracket and the Fascia is removed.

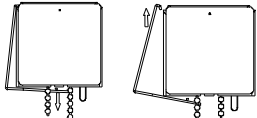

2. After Fascia is removed, rotate the removable pin on bracket, detach the shade (end plug side) from "V" of the bracket and remove the clutch side from the bracket.

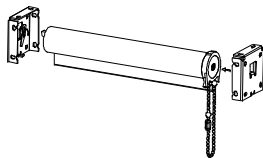

### Manual roller shade with Cassette

#### Installation or removal

#### Brackets Installation

- Mount one bracket on each end of the shade. The distance from center of bracket to the end of the shade is 1 1/4". If more than 2 brackets are needed, the distance between each 2 brackets should be even.

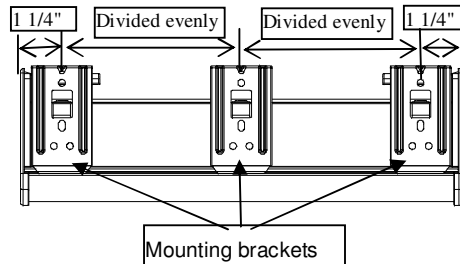

#### For Inside Mount

- The distance from front mounting hole of brackets to front edge of window frame should be more than 3/4". Ensure both of the brackets are at the same horizontal line. Each bracket needs two 1 1/4" hexagon screws for installing.

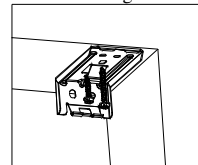

#### For Outside Mount

- The top of each bracket is parallel with the edge of window frame. The distance from mounting holes of brackets to front edge of window frame should be more than 3/4". Both of the brackets should be at the same horizontal line. Each bracket needs two 1 1/4" hexagon screws for installing.

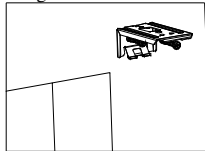

- Use level ruler to check if all brackets are on the same level.

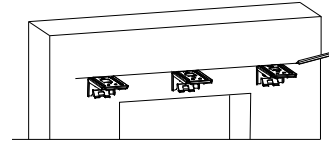

#### 1. Small Cassette installation or removal

##### Installation

Snap the flange on top of Cassette to the front mounting lip of the bracket, and then turn the Cassette upwards to make sure the flange on back of Cassette clasp to the lower mounting lip of the bracket. As shown below:

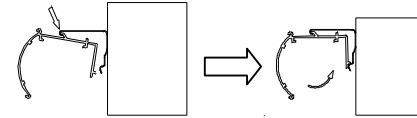

##### Removal(the same for both inside & outside mount)

Push the Cassette horizontally backward, and then turn the Cassette downward to release the flange on top of the Cassette from the front mounting lip of the bracket. As shown below:

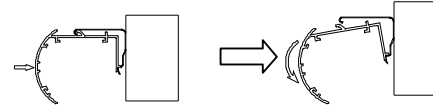

#### 2. Large Cassette installation or removal

##### Installation

Snap the flange on front of the Cassette to the front mounting lip of the bracket, and then turn the Cassette upwards to make sure the flange on back of Cassette and the flange of the end cap clasp to the lower mounting lip of the bracket. As shown below:

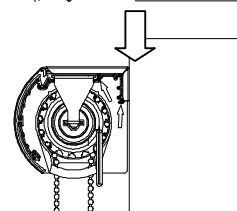
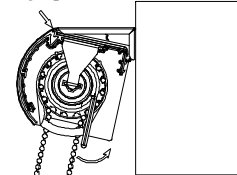

Note: when 3 mounting brackets are used, it is suggested to install the shade to the middle bracket

firstly, and then both ends of shade to the remaining brackets.

##### Removal(the same for both inside & outside mount)

Insert the end of a flat head screwdriver into the gap between top of Cassette and the bracket. Pry the screwdriver to release the Cassette from the bracket. As shown below:

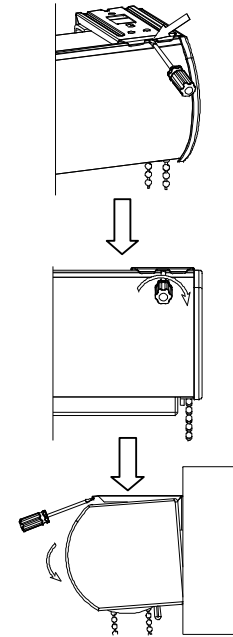

Note: when there are 3 mounting brackets, it is suggested to remove both ends of the shade firstly, and then detach the shade from the middle bracket.

### Safety device installation manual

- The chain cord should be fully extended when fixing the safety device
- Fix the safety device by two 2" flat head screw

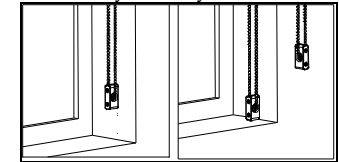

#### Attention:

Shade is heavy. Be careful during installation.