

## LIMITED LIFETIME WARRANTY

The enclosed product is warranted to the original residential retail purchaser as long as the product remains in the original window.

### Covered

**Lifetime:** Entire product against manufacturing defects (i.e. a flaw in the product design, materials, or workmanship that causes the product to no longer function.

**3 Years:** Cords, including internal cords such as those found in cordless blinds or shades.

**5 Years:** All fabric

### Not Covered

1. Normal wear and Tear
2. Any product that fails due to:
  - Abuse • Alterations • Exposure to salt air
  - Improper cleaning • Improper installation
  - Misapplication • Accident
  - Damage from pests/insects/pets
  - Extraordinary use • Improper handling
  - Improper operation • Misuse
3. Natural Wood Products that have:
  - Loss of color intensity
  - Variations in color, grain or texture
  - Warping of wood slats in high humidity areas
4. Costs associated with:
  - Product removal
  - Transportation to and from the retailer
  - Brand label removal • Product re-measure
  - Product reinstallation • Shipping
  - Incidental or consequential damages

In the event there are multiple blinds/shades in the same room, only the defective blind/shade will be replaced

### To Report Shipping Damage:

If damage occurred during shipping, call the place of purchase and report within 7 calendar days, or you may be denied credit for your damaged product.

### To Obtain Service:

If you suspect this product has a manufacturing defect in materials or workmanship:

- Locate the sales receipt
- Call place of purchase

Any unauthorized returns will not be accepted.

### Warranty Remedy:

This shall be your sole remedy under this limited warranty.

If this product is found to have a manufacturing defect in materials or workmanship, we will, at our discretion, do one of the following:

- Repair the product
- Replace the product
- Refund the cost of the product

Colors may vary from lot to lot and may not exactly match sample swatches or previous purchases.

Discontinued items or color selections will be replaced with the closest equivalent current product.

**Your rights under state law:** This lifetime limited warranty gives you specific legal rights, and you may have other rights which vary from state to state. Some states do not allow limitations on how long a warranty lasts, so the above limitations may not apply to you. No agent, representative, dealer or unauthorized employee has the authority to increase or alter the obligation of this warranty. This lifetime limited warranty supersedes any previous versions.

For all questions,  
please call (800) 264-1190

Hours of operation are  
8:00am to 5:00pm CST

# Installation Instructions Roman Shades with Continuous Chain Operation

Part No.MEIN0212 Rev. 2 **ENG**

## Mounting hardware kit includes the following:

Part	Quantity
Mounting Brackets	2 (shades up to 36" wide) 3 (shades 36" to 48" wide) 4 (shades 48" to 96" wide) 5 (shades 96" to 120" wide)
1 1/4" Screws	2 Outside Mount (up to 36" wide) [1 Set-Screw included for each Inside Mount bracket]
3/4" Screws for Outside Mount	8 Inside Mount (up to 36" wide) 3 Outside Mount (36" to 48" wide) 12 Inside Mount (36" to 48" wide) 4 Outside Mount (48" to 96" wide) 16 Inside Mount (48" to 96" wide) 5 Outside Mount (96" to 120" wide) 20 Inside Mount (96" to 120" wide)
Screws for Tension Device	2 (1") Phillips head 2 (3/8") Phillips head per bracket for Outside Mount

Wallboard or Plaster: use anchors specifically designed for hollow walls (not included).  
Concrete, Stone, Brick: use a masonry drill bit and anchors or screws specifically designed for masonry (not included).

## Tools Required:

Pencil, tape measure, level, screw driver, scissors, step stool, drill, utility knife.

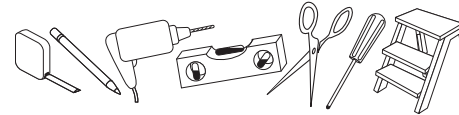

## Installation:

### For Outside Mounting

One bracket should be positioned about 2" to 6" from each end of the head rail. For wider shades that require 3 or more brackets, these should be spaced evenly between the two outermost brackets. Hold the shade in place and mark the desired bracket locations with a pencil.

The brackets must be level – use a Spirit Level if necessary to assure proper alignment.

Attach the brackets to the wall or window

frame first. Pre-drill the mounting holes using a 5/64" drill bit, and then screw the brackets in place.

Place the head rail against the brackets as illustrated – center the shade over the window opening – then mark the location of each mounting hole on the head rail. Pierce the fabric at the hole locations using the tip of a screw, then pre-drill the mounting holes using a 5/64" drill bit. Attach the shade to the brackets using the 3/4" screws provided.

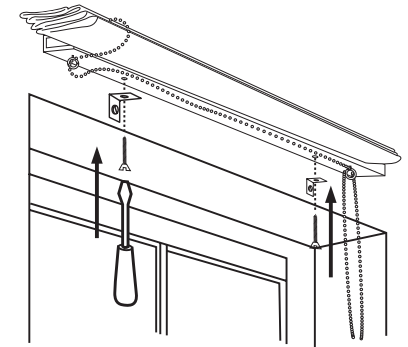

### For Inside Mounting:

The dedicated Inside Mount brackets are designed to simplify installation.

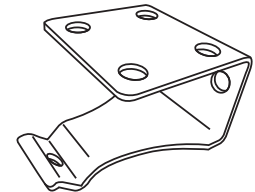

However, extra steps are required to realize this benefit.

Specifically, you must slit the fabric of the Back Valance for Inside Mount Cord Control shades.

[Note: if used for Outside Mounts it is necessary to cut through the liner and face fabric.]

The recommended installation sequence

is as follows:

1. Place the shade face down on a clean surface – brackets should be positioned between the lift cords – hold a bracket at each selected position and pencil mark both sides of the bracket – use a tape measure to determine the exact distance of each pencil mark from one end of the head rail – jot-down the measurements as these will be used to position the brackets when attached to the window frame.

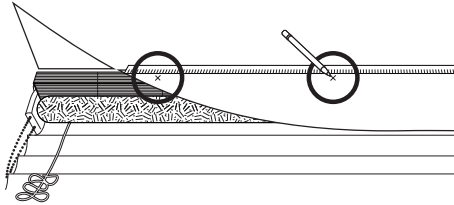

2. Using the pencil marks from Step 1 – pencil mark 1-1/2” (the width of each bracket) lines where the fabric meets the bottom edge of the head rail. Pierce the fabric at one end of each line with a utility knife, and slit the fabric for the entire length of the line – a sawing motion with the knife works best.

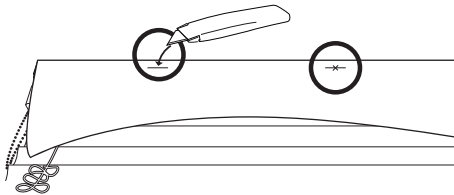

[Remember that for Outside Mount shades, you are cutting through two layers of fabric.]

3. Attach the Brackets to the top inside of the window opening. Use the measurements from Step 1 and pencil mark the bracket locations.

Important: right becomes left and vice versa when the shade is mounted in the window opening – in other words the back-left of the shade becomes the front-right when turned around to go into the window. Position the brackets at the pencil marks, and then mark the screw hole locations for each bracket. Pre-drill the screw holes with a 3/32”

drill bit and attach the brackets with the screws provided.

4. Position the shade so that the bottom-front of each bracket goes through the holes cut in the fabric at the back of the head rail. A second set of hands is useful, but it can be done by one person. Slide the head rail fully into the brackets.

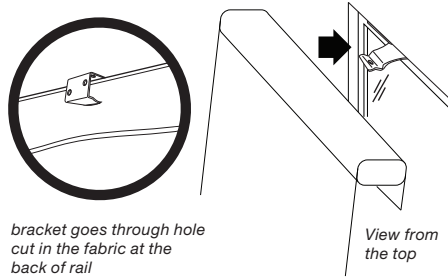

5. Secure the shade to the brackets by tightening the 1/2” set-screws.

Inside Mount – lift the front of the shade to attach the set-screws.

Outside Mount – lift the front valance to attach the set-screws.

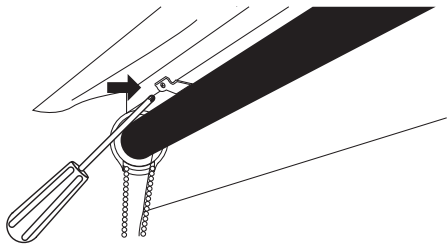

#### Attach the Chain Tension Device

The Tension Device must be attached per these instructions in order for your shade to function properly.

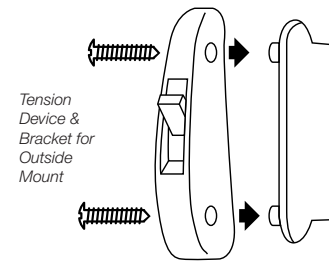
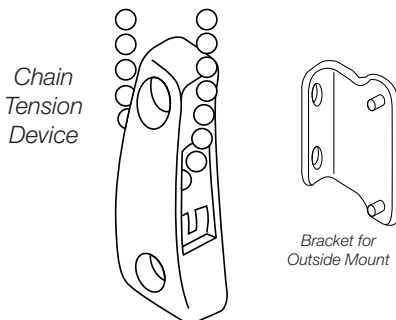

Carefully unwrap the control cord/chain and tension device. Cut and remove the zip-tie.

While holding the tension device in one hand, pull the plunger away from the bead chain with the other hand. Lift the bead chain out of the bead locking groove and slide the tension device to the bottom of the chain loop.

Pull the tension device down until the bead chain is fully tensioned (plunger will be at the top) and then move the tension device up approximately 1/8”.

Mark the screw locations on the wall or window frame with a pencil.

**Inside Mount:** If mounting into wood, predrill screw holes and then install the tension device using the 1” Phillips head screws provided.

If not securing into wood, use appropriate anchors for the substrate and follow the anchor manufacturer’s instructions.

**Outside Mount:** Align the mounting bracket screw holes with the pencil marks. If mounting into wood, predrill screw holes and then install the mounting bracket using the 1” Phillips head screws provided.

If not securing into wood, use appropriate anchors for the substrate and follow manufacturer’s instructions.

Press the tension device onto the mounting bracket posts. Carefully install the 3/8” Phillips head screws provided, through the tension device into the mounting bracket using a Phillips head screwdriver.

#### DO NOT OVER-TIGHTEN!

#### How to Operate Cord Control Shades

Pulling the cord smoothly and slowly in one direction raises the shade; pulling it in the other direction lowers it. On shades where

the fabric rolls against the window, the front cord lifts the shade. On shades where the fabric rolls toward the room, the rear cord lifts the shade.

#### General Cleaning Guidance:

- Dry Cleaning is the best method to clean soiled soft window treatments.
- However, on 100% Polyester, Cotton/ Poly blends and 100% Cotton or 100% Linen you may: Spot clean with warm soapy water using mild detergent and a clean sponge. Air-dry and then steam or iron.

## ! WARNING

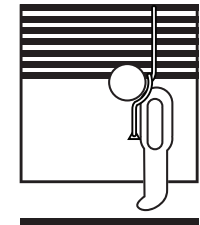

#### Window Blind Cord Can STRANGLE Your Child

- Children can climb furniture to reach cords.
- Move crib and furniture away.
- Keep all cords out of children’s reach.
- Attach tension device to wall or floor.
- Fasteners provided with tension device may not be appropriate for all amounting surfaces.
- Use appropriate anchors for the mounting surface conditions.